

UPLIFT DESK®

Lift Standing Desk Converter Instructions
UDA110-SML

Package contents

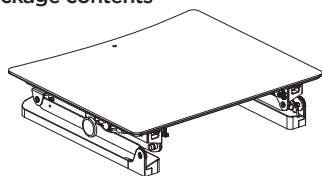

Main unit

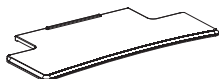

Keyboard tray

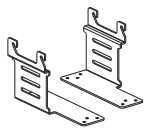

Tray brackets
(qty 2)



Hinge cover
(qty 2)



Screws
(qty 8)

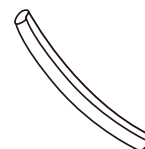

Velcro sheath
(qty 1)



Cable mounts
(qty 4)

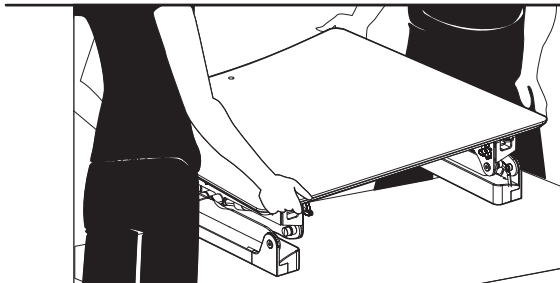

Step 1

Unpack the box and verify the contents against the parts above. Clear off the surface you intend to use the UPLIFT Desk Lift Standing Converter on, and ensure there is at least 29" w by 24" d space for it. Two people should lift the main unit and place it on the intended surface.

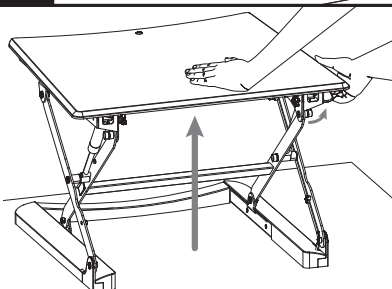

Step 2

Raise the Main unit to a higher position so that you can easily access the space underneath, to later attach the keyboard tray. Grip the handle on the right side squeeze, and lift. Use your left hand to help support and stabilize the converter when raising.

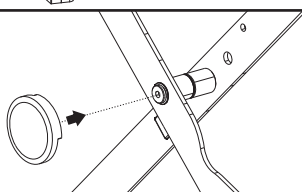

Step 3

Attach a hinge cover to each connecting arm as pictured.

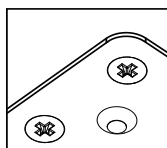
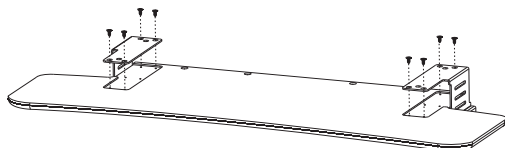

Step 4

Using a Phillips head screwdriver, connect the tray brackets to the keyboard tray using the included screws.

▲ Note: Tighten the screws only until the head is flush with the tray brackets. Going any tighter may strip the screw and damage the keyboard tray.

Step 5

Hang the keyboard tray assembly on the knobs, and once in place, tighten.

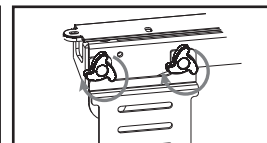
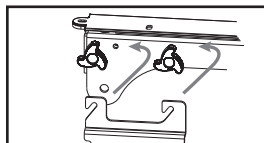
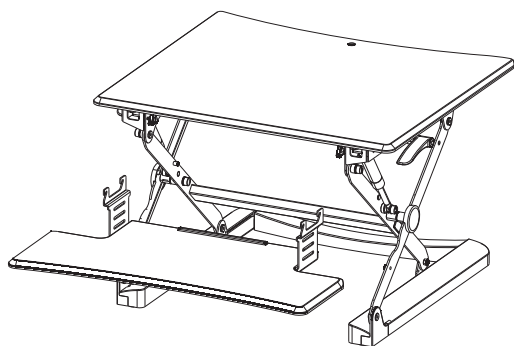

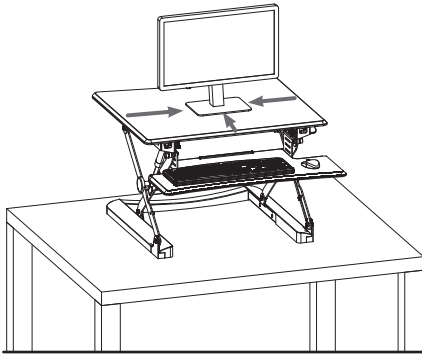

Step 6

You can now add your devices and work items to the unit. Keep them centered and away from the edge of the main worksurface, to prevent them from falling.

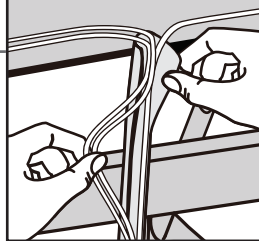
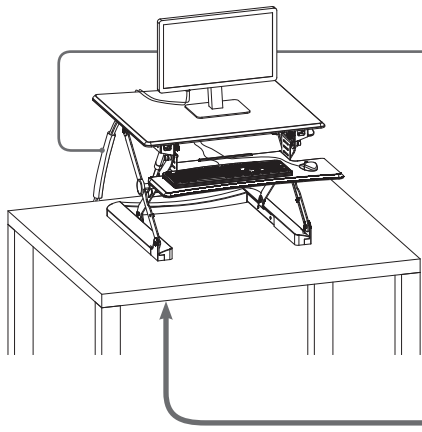

Step 7

Be mindful of any wires hanging from your worksurface. Keep them clear of the cross joints of the main unit.

To gather several cables together, use the Velcro sheath. Open it and run your cables through it, then close. This will keep all cables together.

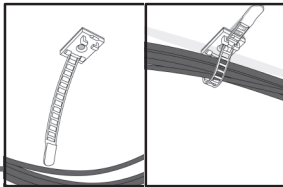

The cable mounts can be placed on the back or under your table to further secure your cables and keep them from moving too much. Just make sure that there is enough slack in the wires to allow the unit to raise and lower without pulling your devices off the work surface.



CAUTIONS & WARNINGS



CAUTION: Read all instructions before installing. Failure to install properly may result in damage or personal injury.



CAUTION: Keep hands clear during operation! Do not reach into the mechanism near the gas spring.



CAUTION: The maximum load capacity of the entire unit is 33lbs (4 lbs for the keyboard tray). Please do not overload.



CAUTION: Keep devices centered and away from the edge of the main worksurface, to prevent them from falling.



CAUTION: Make sure that the wires for your devices have enough slack. This will prevent your devices from being pulled off the unit workstation when raising the unit.



CAUTION: When moving the unit, adjust the unit to its highest position, remove all devices to avoid harm or damage.



CAUTION: When moving the unit, move it carefully with two people, to avoid injury and damage to the product and surroundings.

© **Copyright Notice:** These instructions are a component of the UPLIFT Desk Lift Standing Converter. These instructions are part of the scope of delivery, even if the item is resold. These instructions are also available on the UPLIFT Desk website: upliftdesk.com. Excerpts or copies may not be forwarded to third parties or used in any other published form without the prior written consent of UPLIFT Desk. These instructions are subject to United States copyright law.